

military tent

M.A.D.-CIVIL

BASE FABRIC

canvas: PES and TanCate cotton blend (50/50), 420 g/m², water-repellent impregnated (450 mm HH), anti-rot and anti-mold treated
packaging: PE fabric

THREE-LAYER WINDOW

mesh: 100% PES, plasticised, resistant from -30 °C to +70 °C
transparent foil lid: resistant from -22 °C to +66 °C, UV stabilised
canvas lid: base fabric

BOTTOM

the tent is bottomless

FRAME

aluminium, ø 40 × 1.5 mm
roof cross poles: 6 pcs, 172.1 cm
longitudinal poles: 6 pcs, 175.5 cm
standing pole: 6 pcs, 160 cm (+ steel legs)

aluminium, steel, ø 40 × 1.5 mm
diagonal spacers: 4 pcs, 90 cm

FRAME CONNECTORS

steel, ø 35 × 1.5 mm
4-legged connectors: 3 kos
3-legged connectors: 6 kos

ACCESSORIES

VK pegs: 32 pcs, 33 cm
synth. ropes + PVC tensioners: 10 pcs, 450 cm, ø 6 mm
hammer: 1 pcs, 800 g
wrenches: 1 pcs, no. 13
bags (packaging): 4 pcs

DIMENSIONS

width: 415 cm
length: 365 cm
ridge height: 235 cm
side height: 160 cm

WEIGHT

canvas: 20 kg
frames: 27.9 kg
accessories: 9 kg
bags (packaging): 4 kg

FULL TRANSPORT BAGS (VOLUME)

canvas: 1 pcs, 80 × 65 × 25 cm (0.13 m³)
frames: 1 pcs, 260 × 30 × 20 cm (0.16 m³)
connectors: 1 pcs, ø 50 × 70 cm (0.14 m³)
accessories: 1 pcs, ø 45 × 55 cm (0.09 m³)

LIVING AREA

15.2 m²

TOTAL WEIGHT

61 kg

ACCOMMODATION FOR

8 persons

NO. OF PARTS

1 pcs

TOTAL LENGTH

365 cm

TENT CODE

301/003

COLOUR CHART

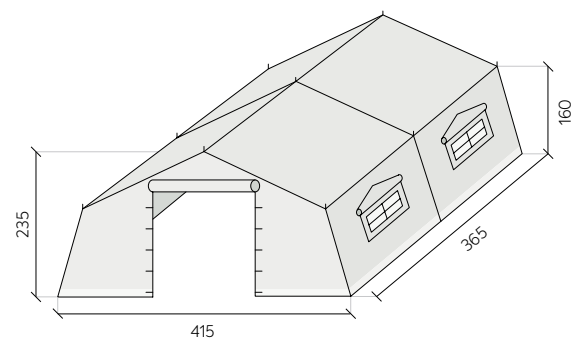
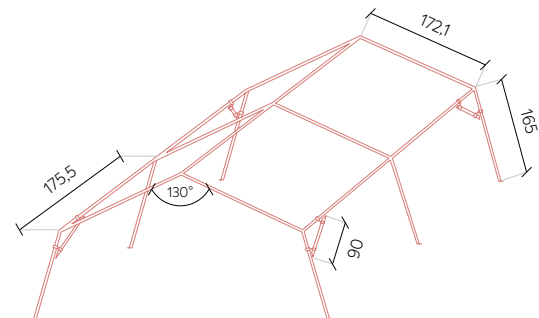
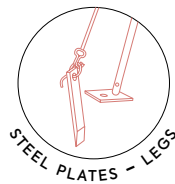

tent characteristics and usage

- The innovative system for providing statics increases the durability and stability of the tent.
- The tent can be exposed to higher loads (snow, wind...).
- A strong frame prolongs the lifespan of the tent (at least 15 years)
- 5-year warranty.
- Multi-purpose stand-alone unit
- Suitable for wind speeds up to approx. 72 km/h (with additional anchoring for yet higher wind speeds).

The M.A.D.-CIVIL group accommodation tent is a multi-purpose and stand-alone unit. It offers living conditions to small groups in case of natural and other disasters as well as refugee crises. This way we can accommodate a small family in one tent. It can also be used to house the headquarters of the Civil protection forces, the military, the police, and members of other protection and rescue forces. In comparison to the MV and M models, the CIVIL tent is a complete unit and does not have a modular extension option, which also indicates the basic purpose of the tent. The CIVIL tent boasts an innovative system for providing statics and thus increasing the durability and stability of the tent. The front door opens to a roll, while the rear door has a curtain entrance with the possibility of installing a removable cabin (additional equipment).











TENT MAINTENANCE AND CLEANING

Brush the canvas parts and, if necessary, wash them with a jet of water. **Use only a softer brush.** Spread out the tent and let it dry. Wash the frame and let it dry. Canvas parts, frame parts, and accessories should be packed and stored exclusively completely dry. **Machine washing, dry-cleaning, bleaching, ironing, or tumble drying of canvases is not allowed.** Tears and other damage to the outer canvas should be repaired by the manufacturer.

TECHNICAL DOCUMENTATION

The tent is manufactured in accordance with the Prestandard SIS EN-1999-1-1, Eurocode pt. 9. Technical documentation and static assessment are created in accordance with the first indent of Article 5 of the Mechanical Resistance And Stability of Construction Works (Official Gazette of RS No. 101/2005).

 WATER-REPELLENT fabric	 STRONG fabric	 UV-RESISTANT fabric
 BREATHABLE fabric	 5-YEAR warranty	 DURABLE fabric
 fabric resistant to MOLD AND ROT	 automatic HUMIDITY CONTROL	